

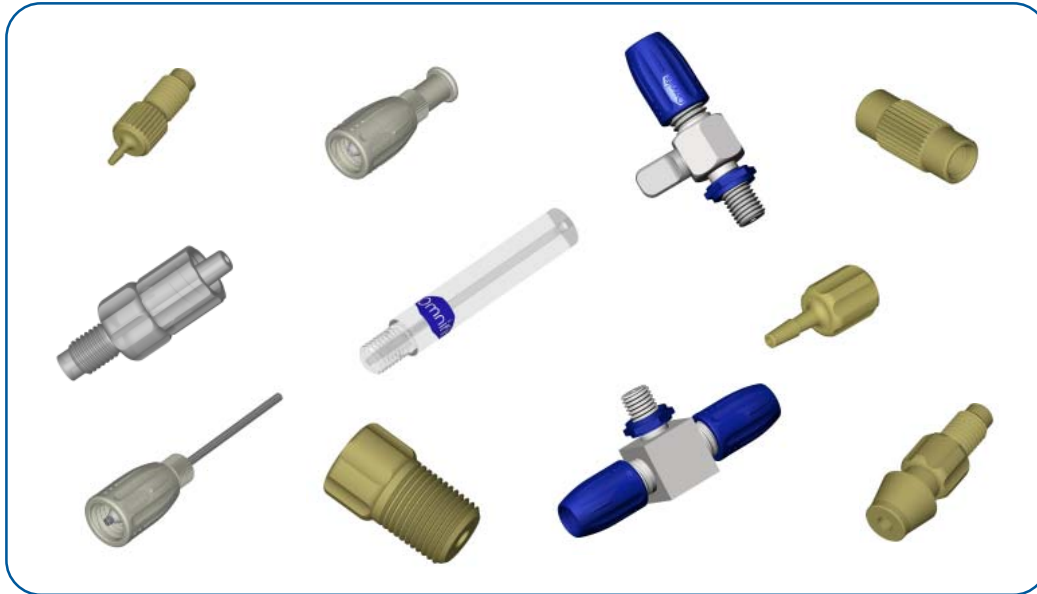

# Adaptors & Couplings



*Inside.....*

- Barbed Adaptors..... 2*
- Male ..... 2*
- Female ..... 2*
- 1/4"-28 Adaptors ..... 3*
- 'Omnifit Cap' Adaptors ..... 3*
- Variable Bore Adaptors ..... 4*
- Couplings ..... 4*

## Chemically inert adaptors and couplings for a variety of thread sizes and tubing types

- Luer, 1/4"-28, barbed and 'Omnifit Cap' connection types
- Excellent chemical resistance
- Versions for hardwall and softwall tubing
- Custom designs available for OEM applications

### Barbed Adaptors

Omnifit barbed adaptors are designed for use with soft wall tubing. They are machined rather than moulded and this gives a superior barb to retain soft wall tubing.

### 1/4"-28 Adaptors

These 1/4"-28 UNF male thread adaptors fit into any 1/4"-28 UNF flat bottom port, as used in most Omnifit valves and connectors, giving quick, push-on connections for softwall tubing. Glass adaptors and adaptors to male and female luer are also available. The glass 1/4"-28 UNF adaptor can be fused to other laboratory glassware to give a convenient threaded connection.

### 'Omnifit Cap' Adaptors

Cap adaptors replace the coloured cap on any of Omnifit's small variable bore connectors and valves to give either quick push-on connections for softwall tubing or luer connections.

### Variable Bore Adaptors

Adaptors to fit 1/4"-28 female ports and adapt to 'Omnifit Cap' connections.

### Couplings

Omnifit threaded couplings are a useful range of 'problem solving' parts that enable you to convert thread sizes quickly and easily. Omnifit couplings are available that accept a 1/4"-28 UNF male fitting at one end and convert this to a range of male and female thread types: 1/4"-28 UNF female, 10-32 female, 3/8" NPT male, 1/8" NPT male, M6, or 1/8" BSPT male.



## Barbed Adaptors

### 1/4"-28 Male to Barb Adaptors

- PEEK™ material
- Excellent chemical resistance
- Extra sharp machined barbs for resilient connections

These male 1/4"-28 to barb adaptors will connect softwall tubing to any female 1/4"-28 port.

Omnifit barbed adaptors are designed for use with softwall tubing. They are machined rather than moulded and this gives a superior barb to retain soft wall tubing.

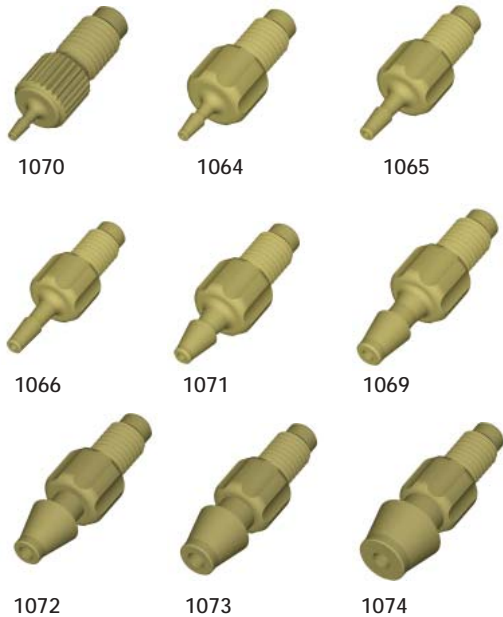

Part Number	Compatible Tubing I.D.	Pack Size
1070	1.0mm	1
1064	1.5mm	1
1065	2.0mm	1
1066	2.5mm	1
1071	3.0mm	1
1069	3.2mm	1
1072	4.0mm	1
1073	6.0mm	1
1074	8.0mm	1

### 1/4"-28 Female to Barb Adaptors

- PEEK™ material
- Excellent chemical resistance
- Extra sharp machined barbs for resilient connections

These female 1/4"-28 to barb adaptors will connect softwall tubing to any male 1/4"-28 thread.

Omnifit barbed adaptors are designed for use with softwall tubing. They are machined rather than moulded and this gives a superior barb to retain softwall tubing.

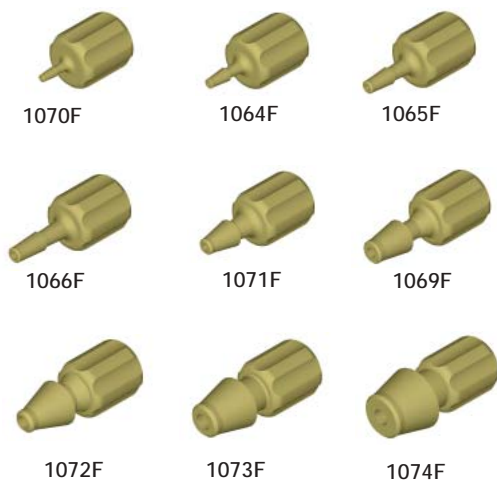

Part Number	Compatible Tubing I.D.	Pack Size
1070F	1.0mm	1
1064F	1.5mm	1
1065F	2.0mm	1
1066F	2.5mm	1
1071F	3.0mm	1
1069F	3.2mm	1
1072F	4.0mm	1
1073F	6.0mm	1
1074F	8.0mm	1

## 1/4"-28 Adaptors

- Inert Tefzel® or glass
- Autoclavable (Tefzel® only)
- Fit any 1/4"-28 UNF flat bottom ports

These adaptors will fit into 1/4"-28 UNF flat bottom ports in most Omnifit connectors and valves. The Tefzel® 1/4"-28 UNF male thread adaptors provide a quick, push-on connection for softwall tubing or luer. Adaptors to male and female Luer are available. The 1/4"-28 UNF male thread glass adaptors fit into any 1/4"-28 UNF flat bottom ports and are suitable for flame fusing onto other glassware.

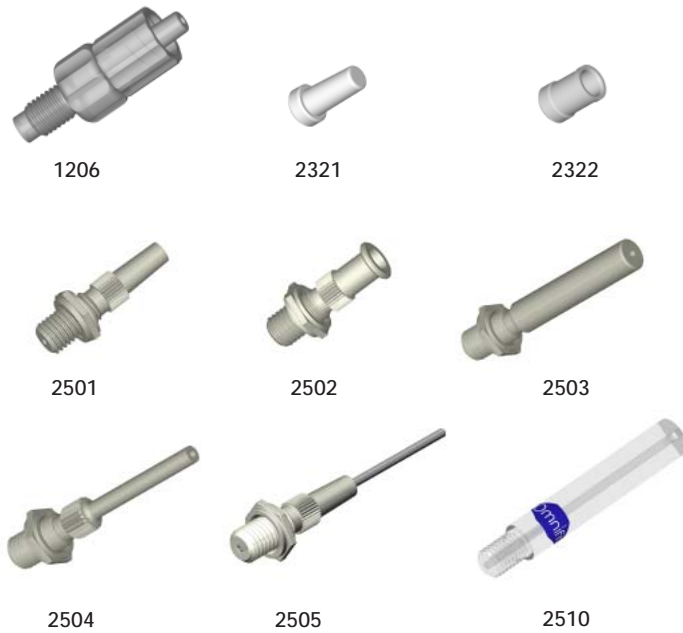

Part Number	Description	Pack Size
1206	Tefzel® Luer lock fitting with Polypropylene lock-ring	1
2321	PTFE plug for female luer	2
2322	PTFE plug for male luer	2
2501	Tefzel® male luer fitting	1
2502	Tefzel® female luer fitting	1
2503	Tefzel® 1/4" O.D. pipe connector	1
2504	Tefzel® 1/8" O.D. pipe connector	1
2505	Tefzel® 1/16" O.D. pipe connector with stainless steel tube	1
2510	1/4" glass tubing with 1.5mm bore	1

## 'Omnifit Cap' Adaptors

- Replaces the colored cap on any 'Omnifit Cap' connector or valve
- Push-on connection for softwall tubing
- Adaptors with luer fittings
- Autoclavable

These adaptors can replace the Omnifit cap on any 'Omnifit Cap' connector or valve to give either quick push-on connections for softwall tubing or luer connections. Cap-to-luer adaptors are available with male or female luer connections. Cap-to-pipe adaptors are available in Tefzel® or stainless steel to accept softwall tubing with the following internal diameters: 1/16", 1/8" and 1/4".

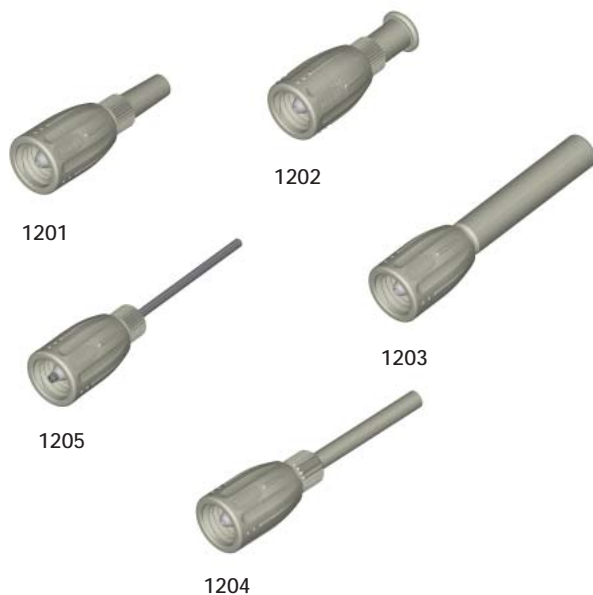

Part Number	Description	Pack Size
1201	Tefzel® male luer fitting	1
1202	Tefzel® female luer fitting	1
1203	Tefzel® 1/4" O.D. pipe connector	1
1204	Tefzel® 1/8" O.D. pipe connector	1
1205	Tefzel® 1/16" O.D. pipe connector with a stainless steel tube	1

## Variable Bore Adaptors

- 50 psi pressure rating
- 1.5mm (.062") bore size
- Chemically inert all-PTFE body
- Polypropylene caps

Omnifit variable bore adaptors allow any size of tubing between 0.5 and 4mm O.D. to be connected to a 1/4"-28 UNF port via the 'Omnifit Cap'. The valved version has a Tefzel® rotor. Each adaptor has a male 1/4"-28 UNF thread that will fit any female 1/4"-28 UNF threaded port.

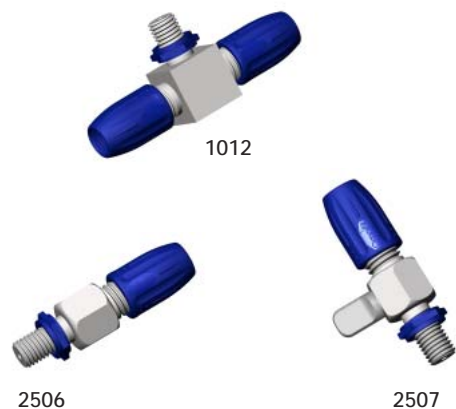

Part Number	Description	Pack Size
1012	3-way 'T' variable bore connector to male 1/4"-28	1
2506	1/4"-28 to variable bore	1
2507	1/4"-28 to variable bore with valve	1

## Couplings

- Excellent chemical resistance
- Polypropylene, PEEK™ or Tefzel®
- Convert different thread sizes

Omnifit threaded couplings are a useful range of 'problem solving' parts that enable you to convert thread sizes quickly and easily.

Omnifit couplings are available that accept a 1/4"-28 UNF male fitting at one end and convert this to a range of male and female thread types including: 1/4"-28 UNF female, 10-32 female, 3/8" NPT male, 1/8" NPT male, 1/8" BSPT male and M6.

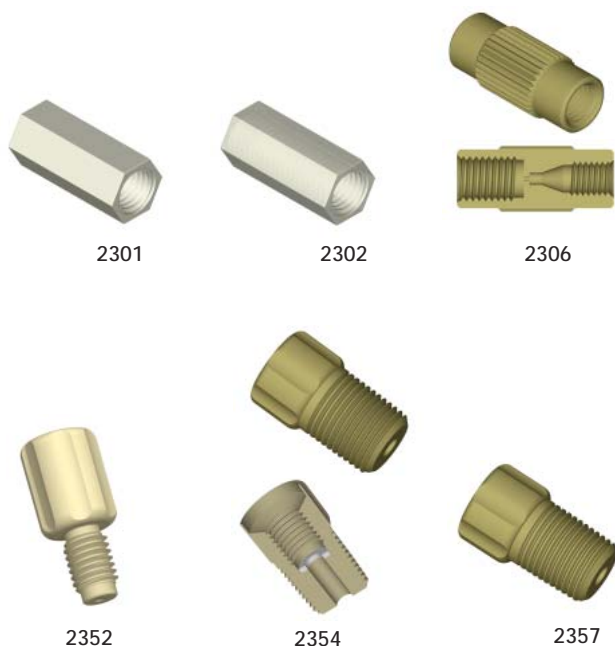

Part Number	Description	Pack Size
2301	Polypropylene two-way coupling	1
2302	Tefzel® two-way coupling	1
2306	PEEK™, 1/4"-28 Female to 10-32 Female	1
2352	PEEK™, 1/4"-28 Female to M6 Male	1
2354	PEEK™, 1/4"-28 Female to 1/8" NPT Male	1
2356	PEEK™, 1/4"-28 Female to 3/8" NPT Male	1
2357	PEEK™, 1/4"-28 Female to 1/8" BSPT Male	1

### Trademarks:

Omni-Lok™ is a trademark of Diba Industries Ltd.  
 PEEK™ is a trademark of Victrex plc  
 Tefzel®, Viton® are registered trademarks of E.I. du Pont de Nemours and Company

Rev. 0205

Diba Industries Inc., 4 Precision Road, Danbury CT 06810 USA  
 t: (203) 744 0773 f: (203) 744 0525 e: sales@dibaind.com

Diba Industries Ltd., 2 College Park, Coldhams Lane, Cambridge CB1 3HD UK  
 t: +44 (0) 1223 472801 f: +44 (0) 1223 416787 e: sales@dibaind.com

Registered in England No. 1138135 VAT Registration No. GB 214 4798 56